

Assignment

Find the volume of each figure. Round your answers to the nearest hundredth, if necessary.

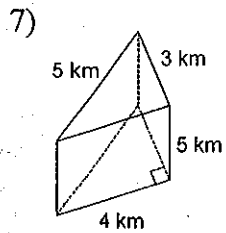

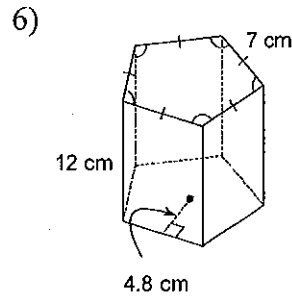
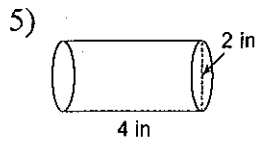
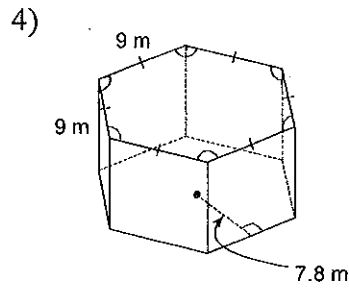
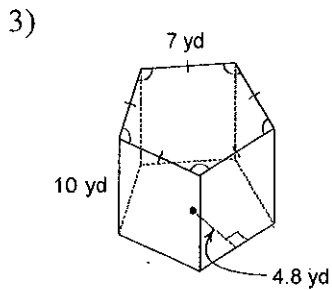
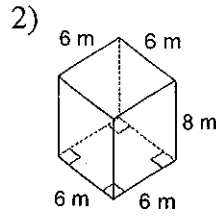
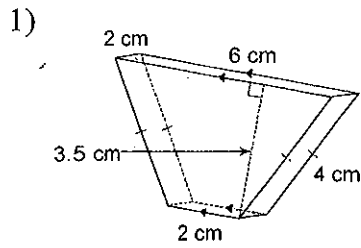
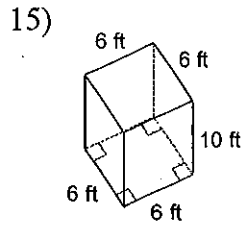
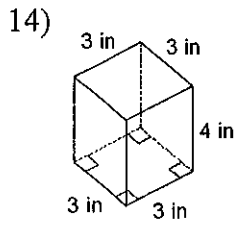
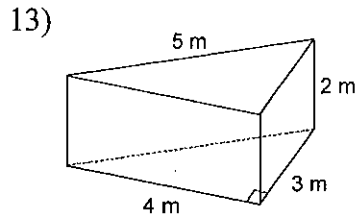
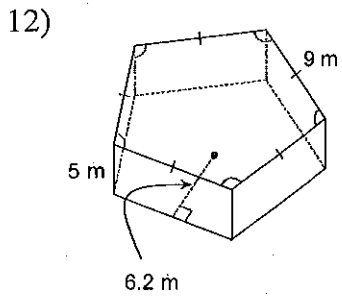
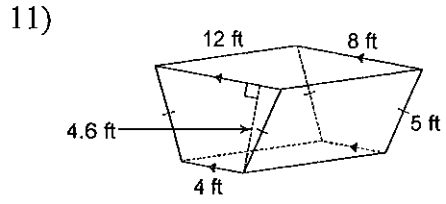
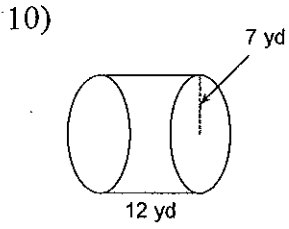
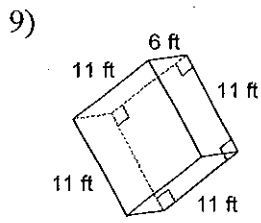
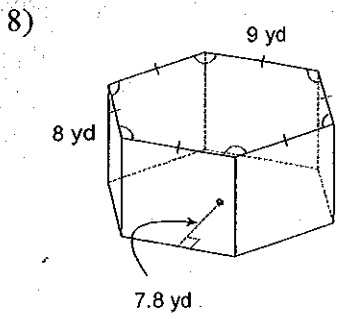

16)

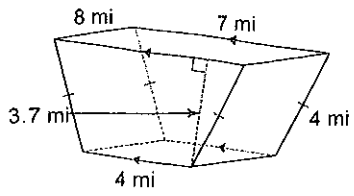

17)

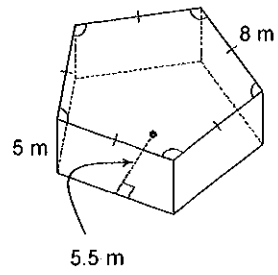

18)

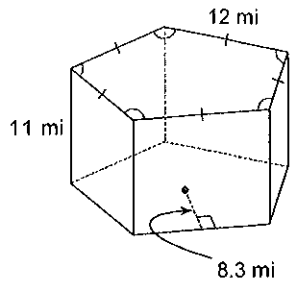

19)

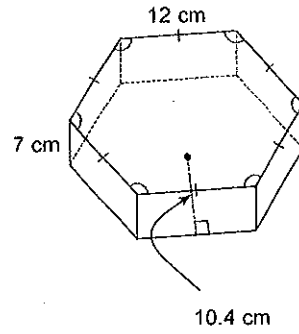

20)

