

Assignment

Find the lateral area of each figure. Round your answers to the nearest hundredth, if necessary.

1)

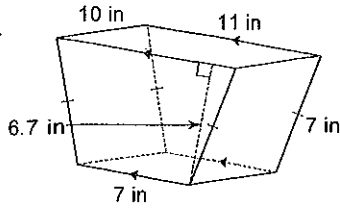

2)

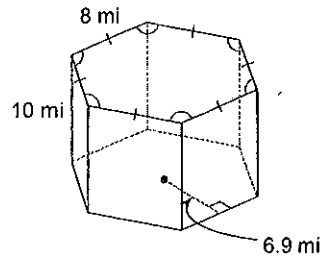

3)

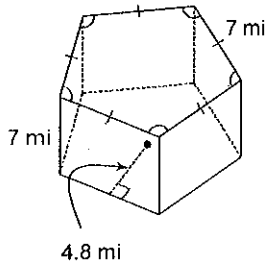

4)

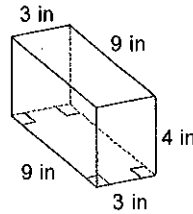

5)

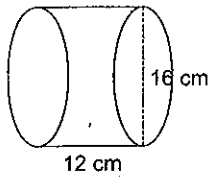

6)

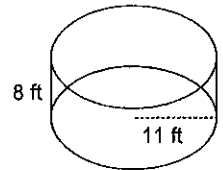

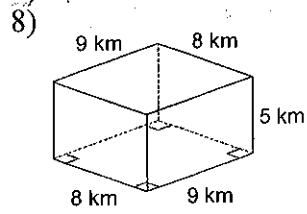
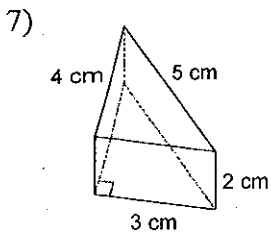

Find the surface area of each figure. Round your answers to the nearest hundredth, if necessary.

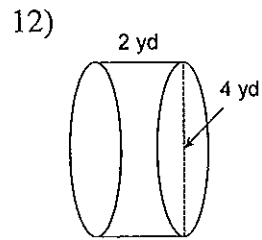
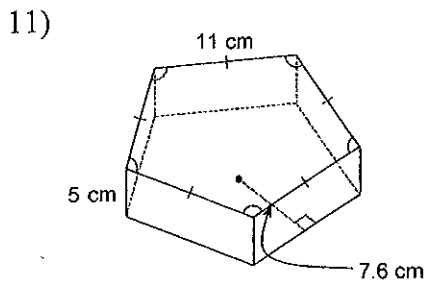
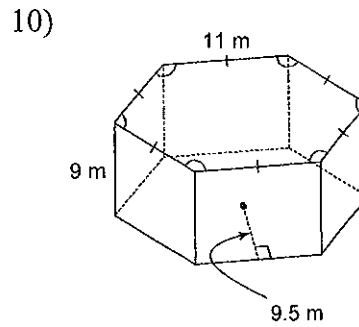
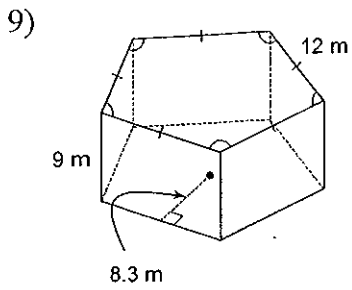

13)

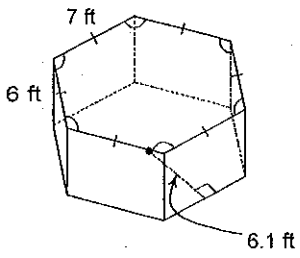

14)

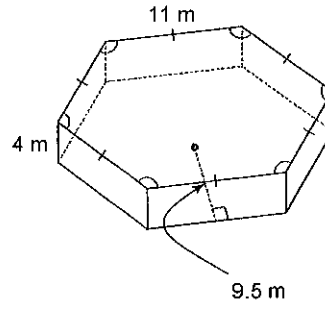

15)

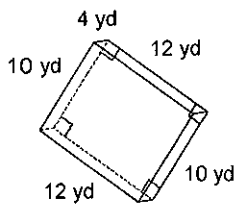

16)

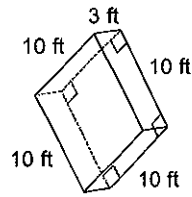

17)

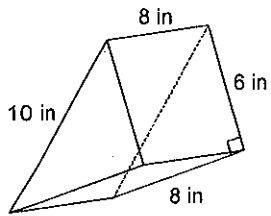

18)

